

Marking and Identification Products

DM Stamps & Specialties

1101 N. Riverfront Drive • Mankato, MN 56001

507-387-4444

Fax: 507-387-4447

Email: custserv@dmstampsdiv.com

www.dmstampsdiv.com



OUR BUSINESS GOAL

As an Industry leader in marking and identification products since 1870 we pride ourselves on providing a wide range of quality products with reasonable pricing. With our elevated level of expertise you will receive efficient and friendly customer service with every inquiry.

MINIMUM ORDER

There is a \$10.00 minimum billing.

SHIPPING POLICY

We ship all products via ground service and add the cost to the invoice. Expedited shipping is available upon request. We can also ship using a third party collect number with an additional handling charge.

DISCOUNT POLICY

Items ordered in large quantities may qualify for a volume discount. Please contact customer service with any questions.

TERMS OF PAYMENT

- Standard terms are net 30 days
- New customers are required to provide at least three trade references for open terms
- Until open account status is granted, all orders will be set up with credit card terms
- Visa, MasterCard, American Express and Discover are accepted
- A \$30.00 service fee will be charged for all returned checks

RETURN POLICY

- A return authorization is required for all returns
- A 25% re-stocking charge applies for stock items
- Custom made products are not returnable

Table of Contents



Ideal & Trodat Stamps

4 - 6

Self-Inking Ideal Text Stamps/Trodat Professional Text, Dater & Numberers, Trodat Classic Daters & Numberers



Xstamper Stamps

7 - 9

Pre-Inked Text & Date Stamps, Stock Stamps



MaxLight Stamps

10 - 11

Pre-Inked Text Stamps



2000+ Stamps

12 - 14

Self-Inking Printer Text Stamps/Office & Classic Text, Dater & Numberers



Industrial Stamps / Numberers & Daters

15 - 16

Xstamper & Ultifast Pre-Inked, Dural Metal Inspector, Pencil Caps & Stick Stamps



RibType & Traditional Hand Stamps

17

RibType Sorts & Kits/Standard Poly and Rubber Stamps



Inks & Embossers

18 - 19

Inks & Pads / Custom Embossers



Stencil Products & Metal Marking Devices

20

Inks, Stencils, Rollers & Pads / Steel Stamps & Detail Press Marking Machines



Corporate Supplies

21

Corporate Record Books/Stock Certificates



Namebadges

22

Custom Engraved, Hot Stamped & Silk Screen Namebadges



Engraved Signs

23

Custom Plastic Engraveable Signs



Interior Signage

24 - 26

Engraved Wall & Desk, Designer/Architectural, ADA & Directory Signs



Award Plaques & Cast Bronze Plaques

27

Award Plaques & Cast Bronze Memorial Plaques



Stamped Tags & Animal Licenses

28

Custom Stamped Tags/Animal Licenses & Receipt Books



Industrial Nameplates & Labels

29 - 36

Model & Serial Number, Decorative Trim, Scales, Bar Code/UID, Promotional, Schematics, Inventory & Asset, Aluminum Foil, Polyester, Destructible Vinyl, Vinyl, Lexan, Digital Printing, Etched Signs, Embossed, Domed, Military Style Tags, Etched Metal, Photosensitive Nameplates & Facility Identification Signs

IDEAL SELF-INKING STAMPS

The **IDEAL** Self-Inking stamps work and feel as great as they look. Their numerous patented features make them one of the best stamps on the market. Just one impression and you will appreciate the ergonomic shape and heavy duty construction. The IDEAL Self-Inking stamps feature precision components for a smooth, quiet action and many years of trouble free operation.

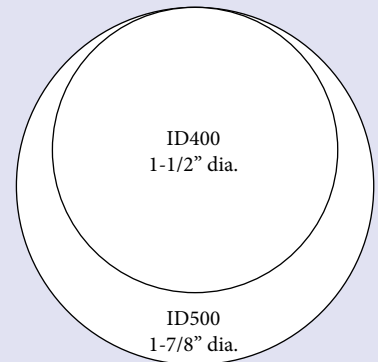
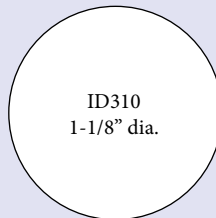
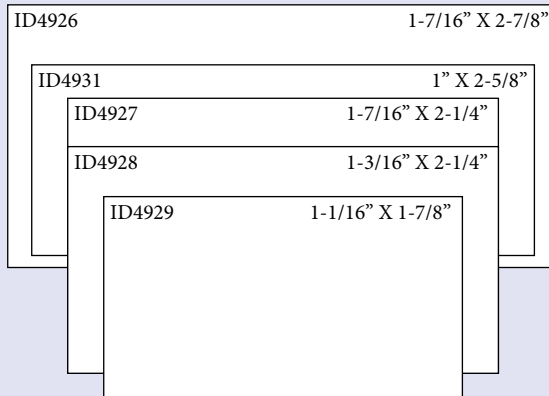
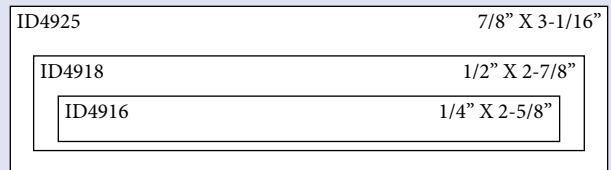
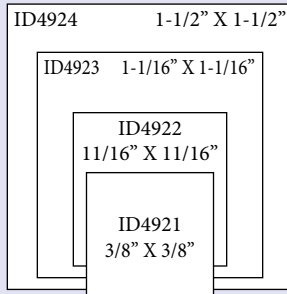
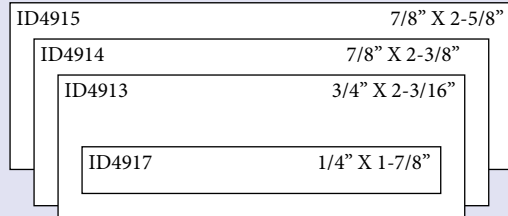
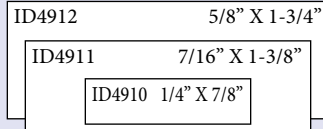

Ideal/Trodat Ink Colors:

Red, Blue, Black, Green, Orange & Purple
 (Black is used if color is not specified)

Please contact Customer Service for more information

TRODAT PROFESSIONAL

The Professional line from Trodat is the perfect stamp for anyone who regularly needs to use a stamp. From its steel core for heavy repeated stamping to its modern ergonomic design you will find it to be the most reliable stamp on the market and with 10 years on the date bands they will last longer than any other brand.

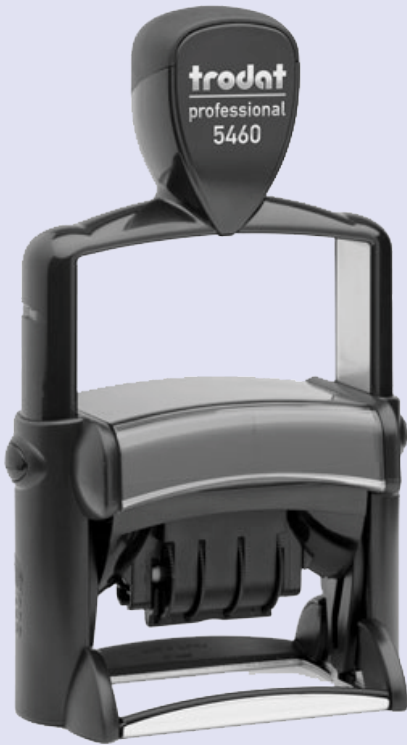

TR5415
1-5/8" dia.

JAN 12 2024

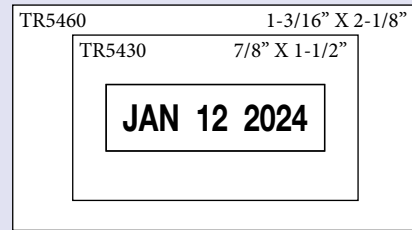

TR5460 1-3/16" X 2-1/8"

TR5430 7/8" X 1-1/2"

JAN 12 2024

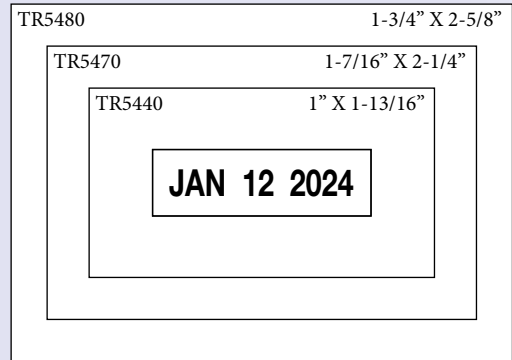

TR5480 1-3/4" X 2-5/8"

TR5470 1-7/16" X 2-1/4"

TR5440 1" X 1-13/16"

JAN 12 2024

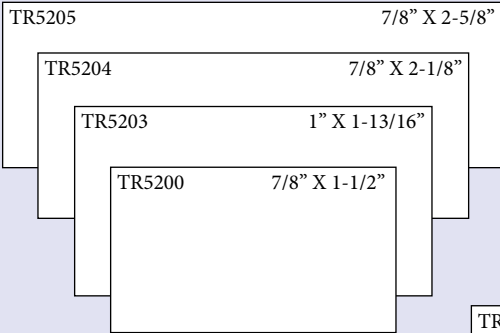

TR5205 7/8" X 2-5/8"

TR5204 7/8" X 2-1/8"

TR5203 1" X 1-13/16"

TR5200 7/8" X 1-1/2"

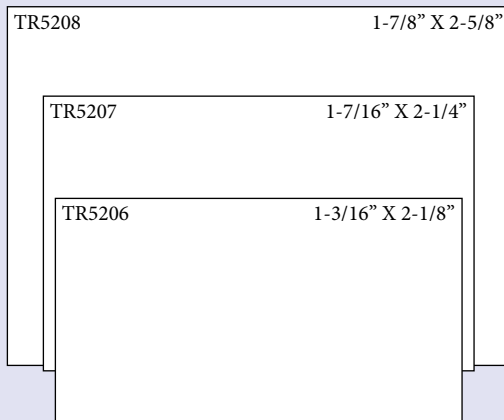

TR5208 1-7/8" X 2-5/8"

TR5207 1-7/16" X 2-1/4"

TR5206 1-3/16" X 2-1/8"

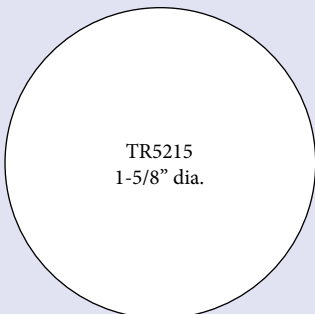

TR5215
1-5/8" dia.

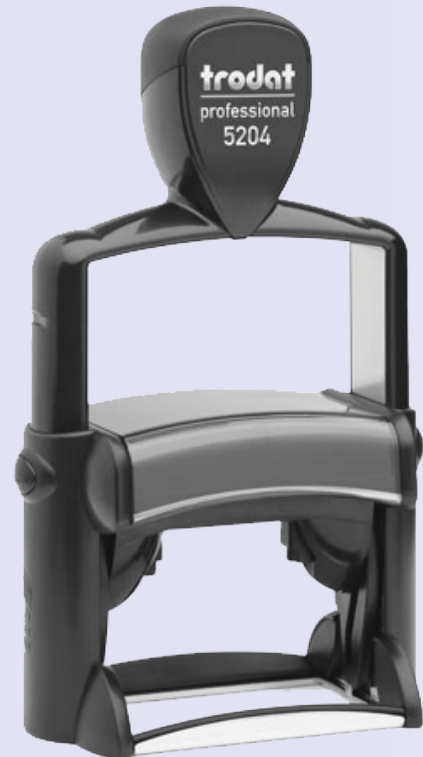

Ideal & Trodat Stamps

Xstamper Stamps

Maxlight Stamps

2000+ Stamps

Industrial Stamps & Numerers

Rib Type & Traditional Hand Stamp

Inks & Embossers

Stencils & Marking Devices

Corporate Supplies

Namebadges

Engraved Signs

Interior Signage

Award Plaques Cast Bronze Plaques

Stamped/Animal Tags

Industrial Nameplates & Labels

SELF-INKING DATERS



TR4724 1-7/16" X 1-7/16"
 ID4750 7/8" X 1-1/2"
JAN 12 2024

ID4726
 ID43132 1-1/8" X 1-1/8" 1-3/8" X 2-7/8"
JAN 12 2024

ID4727 1-7/16" X 2-1/4"
 ID4729 1-1/16" X 1-7/8"
JAN 12 2024

TR46145
 1-5/8" Diameter
JAN 12 2024
 TR46140
 1-1/2" Diameter
JAN 12 2024

TR4817 1/8" Characters
PAID JAN 12 2024

Includes the following phrases:

- 1. ANSWERED
- 2. RECEIVED
- 2. ENTERED
- 4. BACKORDERED
- 5. CHARGED
- 6. PAID
- 7. CANCELED
- 8. CHECKED
- 9. SHIPPED
- 10. BILLED
- 11. DELIVERED
- 12. FAXED

RECEIVED
JAN 12 2024

TR4813
 1/4" X 7/8"
JAN 12 2024

ID4850
JAN 12 2024
 ID4800 3/32"

JAN 12 2024
 ID4810 1/8"

JAN 12 2024
 ID4820 5/32"

Xstamper Stamps

MaxLight Stamps

2000+ Stamps

Industrial Stamps & Numberers

RibType & Traditional Hand Stamp

Inks & Embossers

Stencils & Marking Devices

TRODAT CLASSIC LINE

TR2910/P10 1-7/8" X 2-5/8"
 TR2910/P02 1-3/8" X 1-13/16"
JAN 12 2024

TR2910/P08 1-5/8" X 2-3/8"
 TR2910/P07 1-7/16" X 2-1/4"
 TR2910/P05 1-1/4" X 2"
JAN 12 2024



JAN 12 2024
 TR1000 1/8"

JAN 12 2024
 TR1010 5/32"

JAN 12 2024
 TR1020 3/16"

TR2910/P30
 1-7/8" dia.
JAN 12 2024



Corporate Supplies

Namebadges

Engraved Signs

Interior Signage

Award Plaques Cast Bronze Plaques

Stamped/Animal Tags

Industrial Nameplates & Labels

XSTAMPER PRE-INKED STAMPS

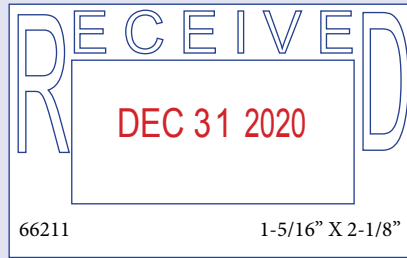

Stock VersaDater

Includes the 8-year Line Dater and one stock Impression Frame from the following three styles. Frame copy prints in blue, date prints in red.

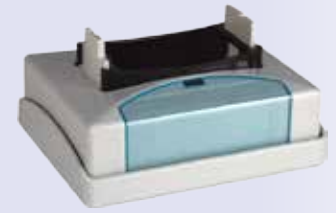
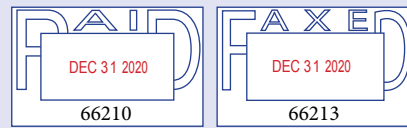

Xstamper Lifetime Guarantee
 Our Lifetime guarantee says it all - we stand behind our quality products. Our guarantee covers the entire stamp, not just the mechanical parts. The life of the Xstamper can be 25 years or more. If you are not 100% satisfied with your Xstamper, we'll do whatever it takes to get it right.

- Ideal & Trodat Stamps
- Xstamper Stamps
- Maxlight Stamps
- 2000+ Stamps
- Industrial Stamps & Numbers
- Rib Type & Traditional Hand Stamp
- Inks & Embossers
- Stencils & Marking Devices
- Corporate Supplies
- Namebadges
- Engraved Signs
- Interior Signage
- Award Plaques Cast Bronze
- Stamped/Animal Tags
- Industrial Nameplates & Labels

XSTAMPER PRE-INKED STAMPS



Xstamper offers a full line of shapes and sizes that are specifically engineered for your custom message. Be creative and use your original artwork or select any of our established impression styles. All stamp impressions are laser engraved to provide a perfect impression time after time.

We guarantee it for life!

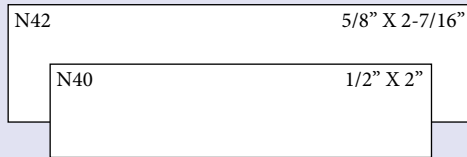
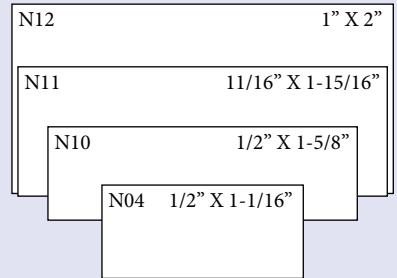
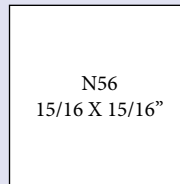
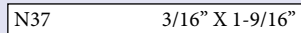
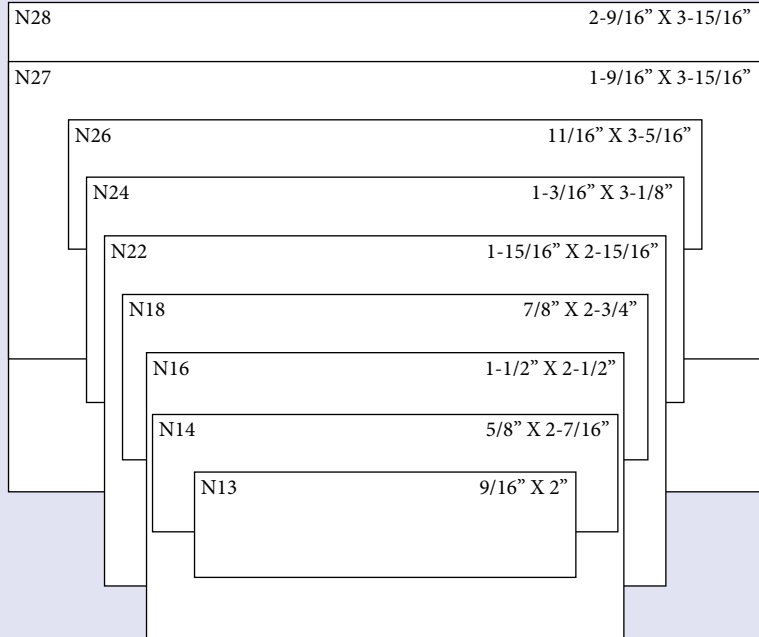

This handy pocket stamp is great for carrying around in your pocket, purse or briefcase and will not leak.

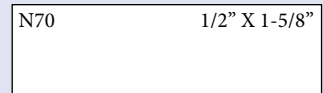

Xstamper Ink Colors:

Red, Blue, Black, Green, Orange & Purple
 Special colors available: Light Blue, Light Green, Pink, Yellow or Brown
 (Black is used if color is not specified)

Use only Xstamper ink to re-ink your stamp.

Please contact Customer Service for more information

Ideal & Trodat Stamps

Xstamper Stamps

MaxLight Stamps

2000+ Stamps

Industrial Stamps & Stamp Numberers

RibType & Traditional Hand Stamp

Inks & Embossers

Stencils & Marking Devices

Corporate Supplies

Namebadges

Engraved Signs

Interior Signage

Award Plaques Cast Bronze Plaques

Stamped/Animal Tags

Industrial Nameplates & Labels

XSTAMPER PRE-INKED STAMPS



N49
1-3/16" dia.



N51
1" dia.



N48
3/4" dia.



N32
5/8" dia.



N30
3/8"



1/4"
N06

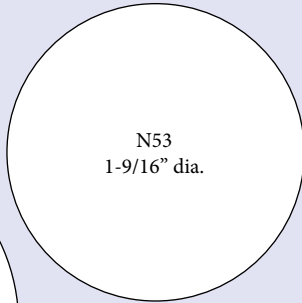

N53
1-9/16" dia.

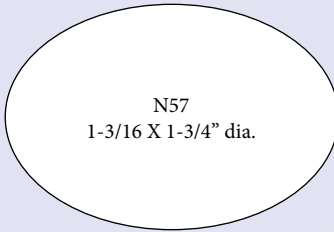

N57
1-3/16 X 1-3/4" dia.



N44
3/8"

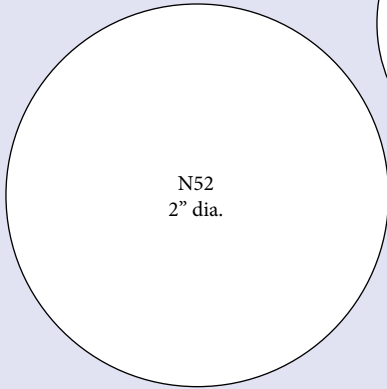

N52
2" dia.

Pencil Cap fits most pens and pencils



N60
1/2"

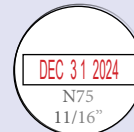

DEC 31 2024
N75
11/16"



Custom XpeDater

The XpeDater prints your custom message with the month, day and year over a 6-year period. A simple twist of the base and a turn of the dial changes the date, eliminating the need for tweezers.



N77
1-3/4" dia.



N78
1-3/4" dia.



N85
1-3/16" dia.

Custom VersaDater

It's the only date stamp you'll ever need. On its own, VersaDater is an 8-year pre-inked line dater. The date is easily changed with a turn of the dial. Snap on a pre-inked Impression Frame and you create a whole new message stamp - *without the new stamp price.*

Date available in red, blue, or black - frames available in any one of 6 colors.

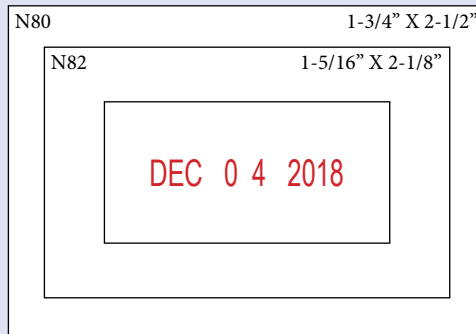

N82

1-5/16" X 2-1/8"

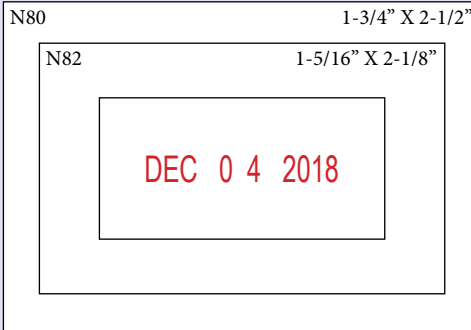

N80

1-3/4" X 2-1/2"



- Stampers
- Maxlight Stamps
- 2000+ Stamps
- Industrial Stamps & Numberers
- Rib Type & Traditional Hand Stamp
- Inks & Embossers
- Stencils & Marking Devices
- Corporate Supplies
- Namebadges
- Engraved Signs
- Interior Signage
- Award Plaques Cast Bronze Plaques
- Stamped/Animal Tags
- Industrial Nameplates & Labels

MAXLIGHT PRE-INKED STAMPS

Ideal & Trodat Stamps

Xstamper Stamps

MaxLight Stamps

2000+ Stamps

Industrial Stamps & Numbers

RibType & Traditional Hand Stamp

Inks & Embossers

Stencils & Marking Devices

Corporate Supplies

Namebadges

Engraved Signs

Interior Signage

Award Plaques Cast Bronze Plaques

Stamped/Animal Tags

Industrial Nameplates & Labels

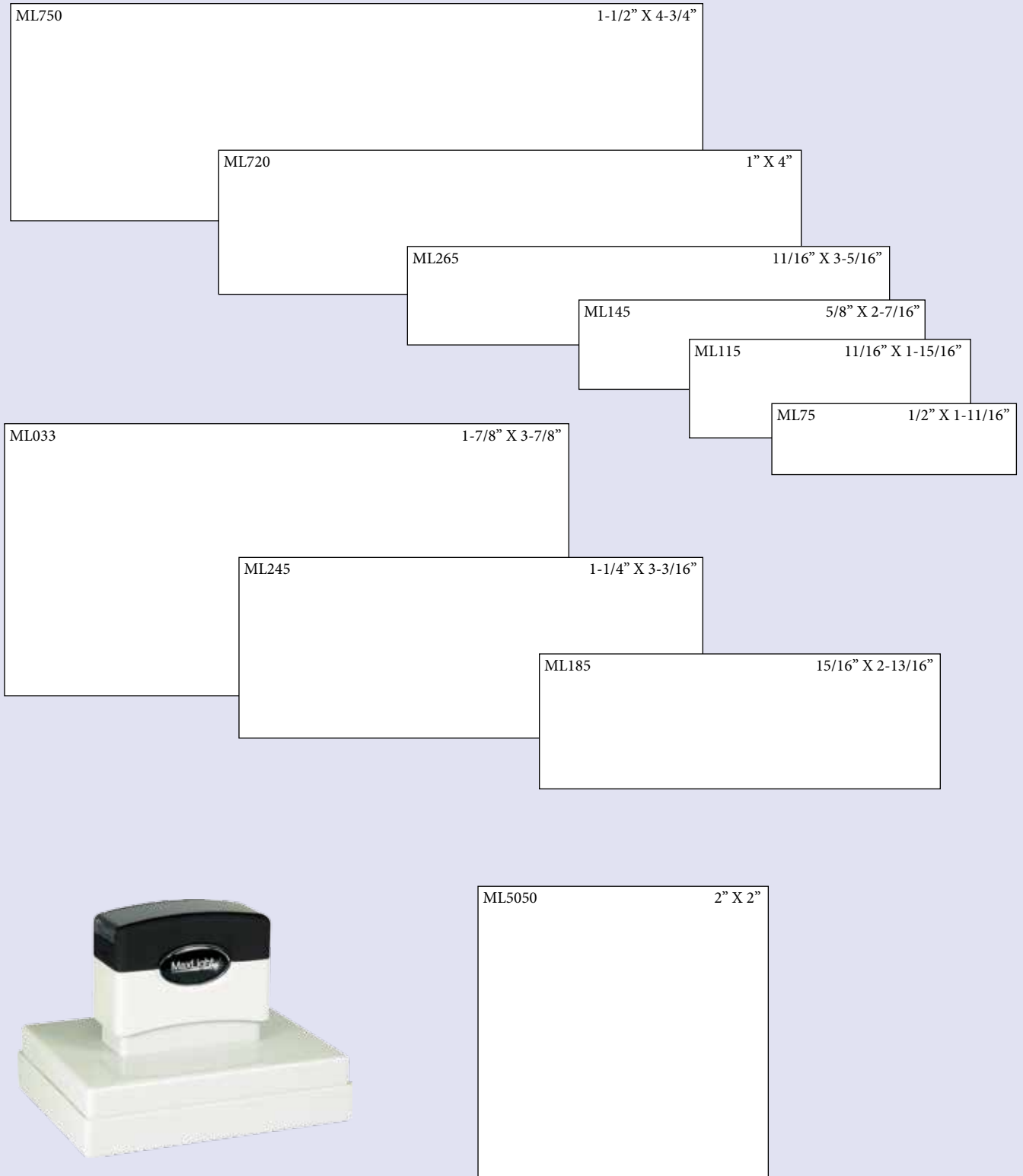

Please contact Customer Service for more information

MAXLIGHT PRE-INKED STAMPS

MaxLight Pre-Inked stamps are designed to exceed your expectations for excellence. The MaxLight ink has been specifically developed to provide excellent print quality guaranteeing excellent impressions that are superior to others and can be re-inked for thousands more precise impressions.

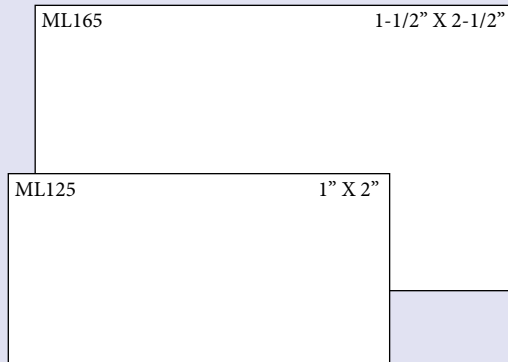
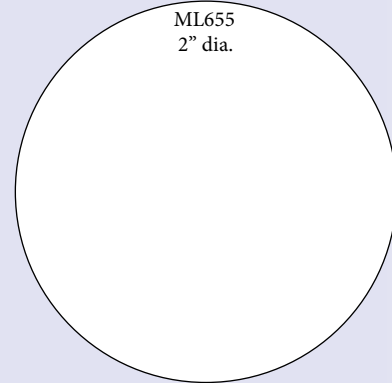

MaxLight Ink Colors:
 Red, Blue, Black, Green & Purple
(Black is used if color is not specified)

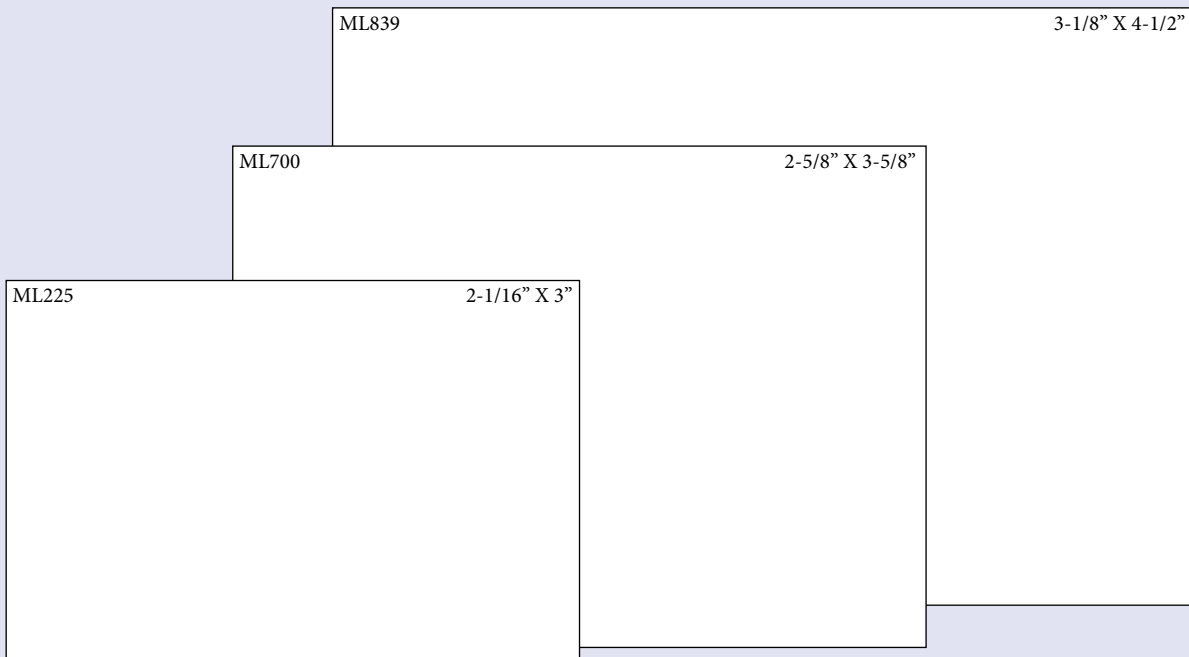

- Ideal & Trodat Stamps
- Xstamper Stamps
- MaxLight Stamps**
- 2000+ Stamps
- Industrial Stamps & Numberers
- Rib Type & Traditional Hand Stamp
- Inks & Embossers
- Stencils & Marking Devices
- Corporate Supplies
- Namebadges
- Engraved Signs
- Interior Signage
- Award Plaques Cast Bronze Plaques
- Stamped/Animal Tags
- Industrial Nameplates & Labels



2000+ PRINTER SELF-INKING DATERS

The 2000+ Self-Inking Date Stamp is a small machine that houses its own stamp pad. A mechanism applies fresh ink to the stamp for every impression. These are perfect for rapid, repeat stamping. Up to 5,000 impressions in each pad.

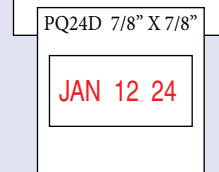
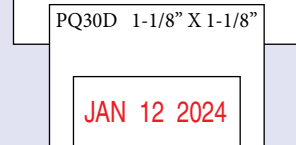
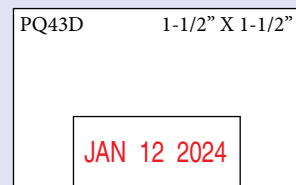
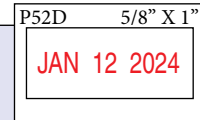
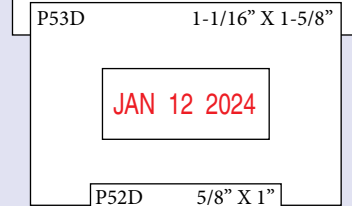
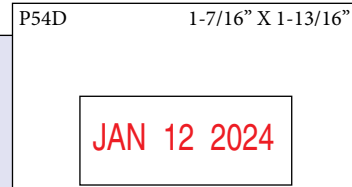
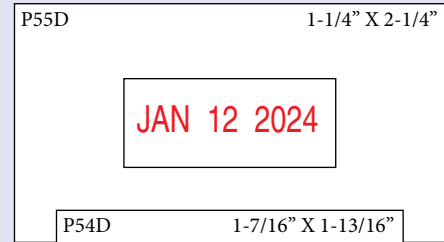
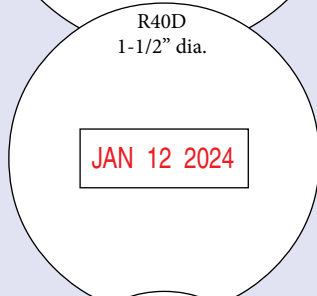
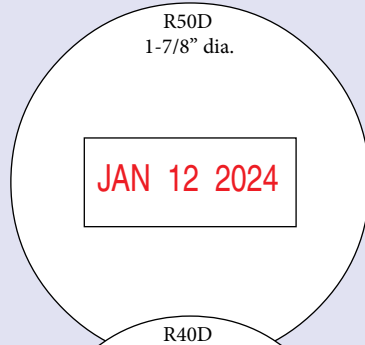

2000+ Ink Colors:
 Red, Blue, Black,
 Green, Orange &
 Purple
*(Black is used if color
 is not specified)*

Ideal & Trodat Stamps

Xstamper Stamps

MaxLight Stamps

2000+ Stamps

Industrial Stamps & Stamp Numberers

RibType & Traditional Hand Stamp

Inks & Embossers

Stencils & Marking Devices

Corporate Supplies

Namebadges

Engraved Signs

Interior Signage

Award Plaques Cast Bronze Plaques

Stamped/Animal Tags

Industrial Nameplates & Labels

2000+ MECHANICAL SELF-INKERS

These Heavy Duty steel framed Self-Inkers are built for industrial applications and are equipped with super smooth oscillations making them easy to operate. The 6 year date bands have a protective cover to protect your fingers from ink contamination when changing the dates.

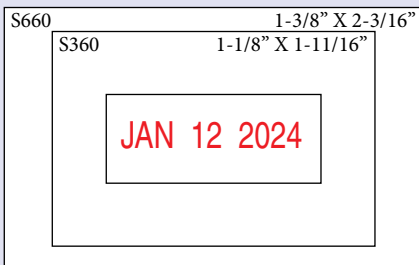
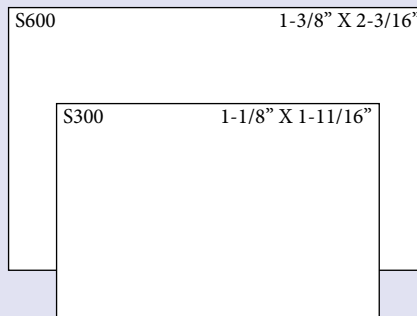
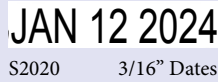
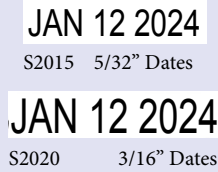
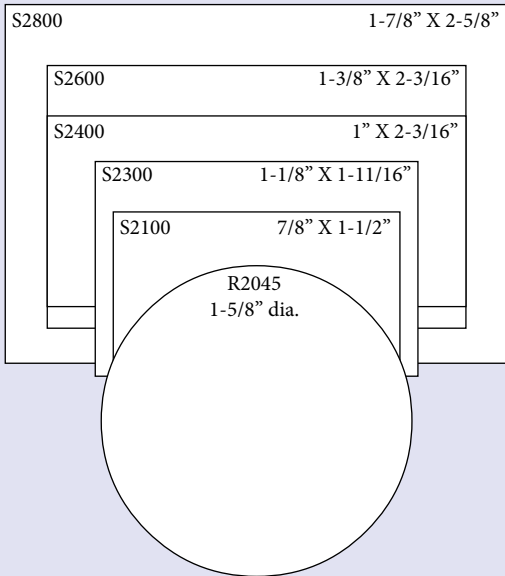
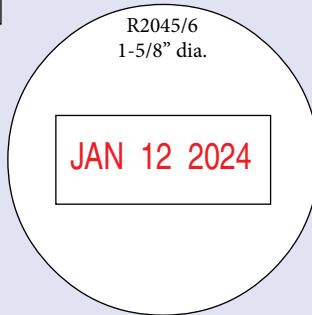
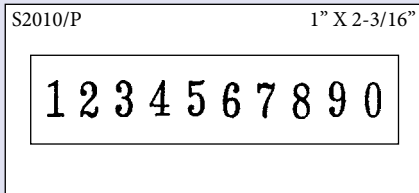
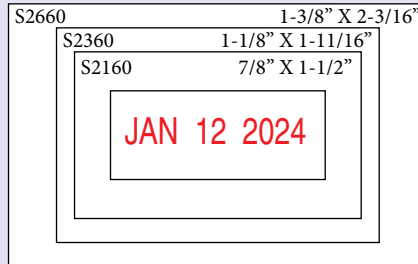
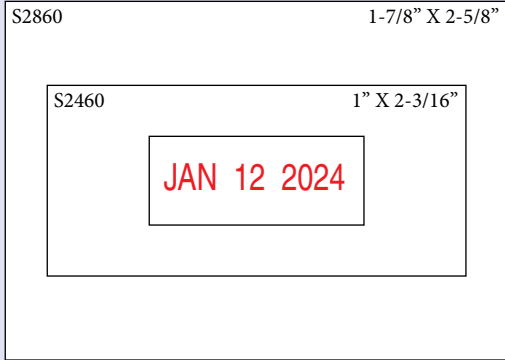

- Stampers
- Maxlight Stamps
- 2000+ Stamps
- Industrial Stamps & Numberers
- Rib Type & Traditional Hand Stamp
- Inks & Embossers
- Stencils & Marking Devices
- Corporate Supplies
- Namebadges
- Engraved Signs
- Interior Signage
- Award Plaques Cast Bronze Plaques
- Stamped/Animal Tags
- Industrial Nameplates & Labels

2000+ SELF-INKING STAMPS



The COSCO 2000+ Self-Inking Stamps are the world's only line of stamps with Microban® anti-microbial protection built into the handle! The quality of these stamps is evident in it's extremely smooth and quiet movement. You can not find self-inkers with more attention to detail.

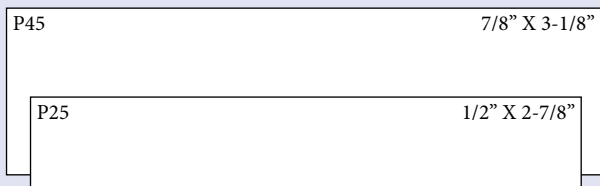
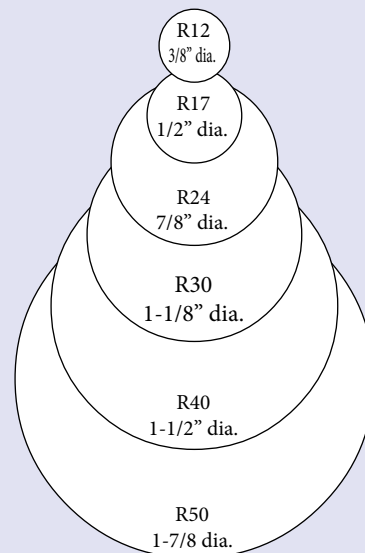
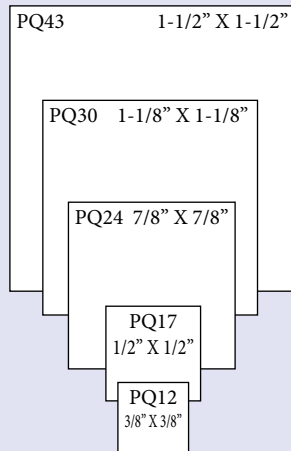
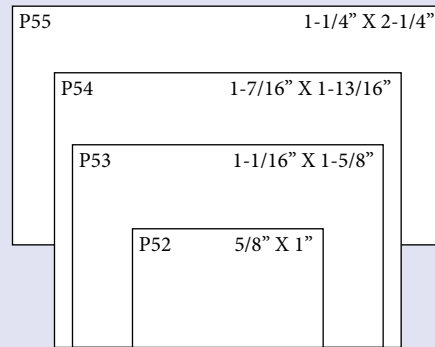
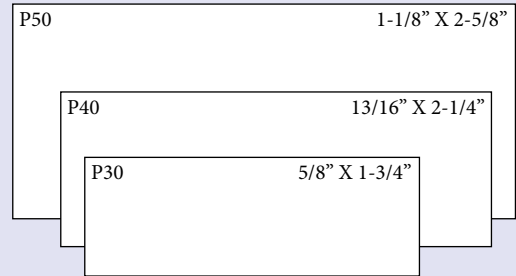

- Ideal & Trodat Stamps
- Xstamper Stamps
- MaxLight Stamps
- 2000+ Stamps
- Industrial Stamps & Stamp Numberers
- RibType & Traditional Hand Stamp
- Inks & Embossers
- Stencils & Marking Devices
- Corporate Supplies
- Namebadges
- Engraved Signs
- Interior Signage
- Award Plaques Cast Bronze Plaques
- Stamped/Animal Tags
- Industrial Nameplates & Labels

Make your mark almost anywhere with our Industrial Pre-Inked and Traditional stamps. These stamps are ideal for marking any slick or hard to mark surface such as metal, glass, plastic, leather, gloss paper, etc.

Xstamper Industrial Stamps

Xstamper Industrial ink is formulated to be fast drying, permanent and water resistant. The uniquely designed caps are engineered to minimize ink from drying out, extending the functional life of the stamp.

Drying time requires only 90-120 seconds.

Colors Available: Red, Blue, Black Green, Purple, White, & Yellow

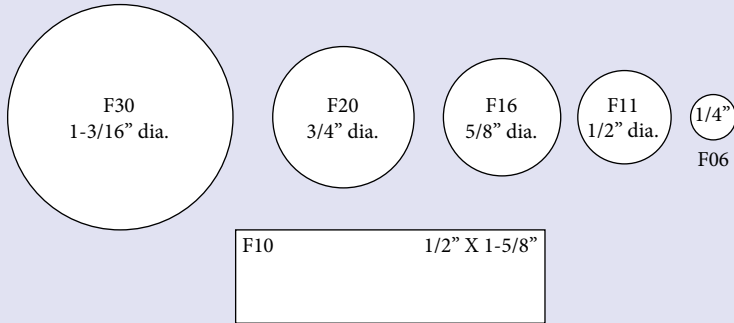

Ultifast Pre-Inked Stamps

The Ultifast marks on almost anything. Ultifast ink is fast drying and water resistant, making it perfect for identifying personal items, photography, industrial equipment and so much more.

Drying time requires only 20-30 seconds.

Colors Available: Red, Blue & Black

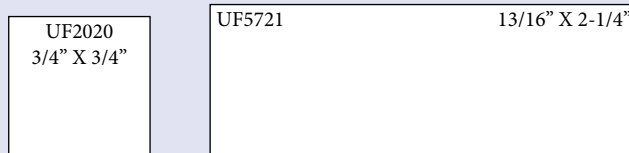

Dural Metal Inspectors

Dural metal inspection stamps are produced with red rubber dies. For use with most fast drying inks and solvents.

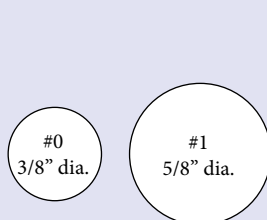

Pencil Caps

Rubber cap fits the end of most standard pencils. Stamps pad is required.

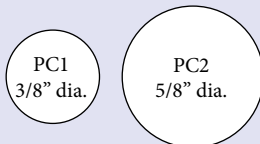

Stick Stamp

The perfect stamp when there isn't room for a regular stamp to make an inspection mark. Custom cut to your specifications. Maximum copy height is 1/4". Stamp pad is required.



Ideal & Trodat Stamps
 Xstamper Stamps
 MaxLight Stamps
 2000+ Stamps
 Industrial Stamps & Numberers
 RibType & Traditional Hand Stamp
 Inks & Embossers
 Stencils & Marking Devices
 Corporate Supplies
 Namebadges
 Engraved Signs
 Interior Signage
 Award Plaques Cast Bronze Plaques
 Stamped/Animal Tags
 Industrial Nameplates & Labels

NUMBERERS/DATERS

Many options of JustRite numberers are available including self-inking and traditional models. When you consider our capabilities of inserting letter bands, dates (in lieu of 6 figure band spaces) or custom molded bands/wrap dies into any position, the possibilities are endless! All numberers come with Gothic typeface unless Roman is specified.



MB-SBD 1-1/4 11/32" X 1-1/4"

DEC 14 2018

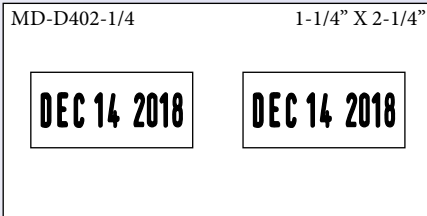

MD-D402-1/4

1-1/4" X 2-1/4"

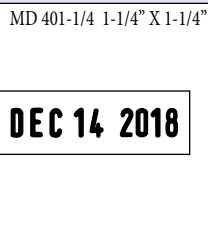

MD 401-1/4 1-1/4" X 1-1/4"

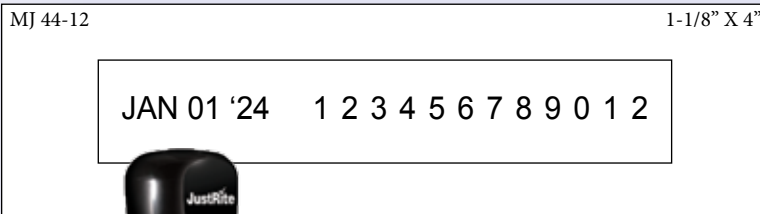

MJ 44-12

1-1/8" X 4"



Local Style Daters with Full Year Bands

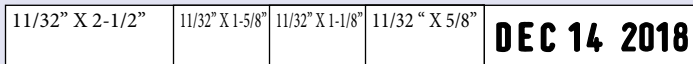

11/32" X 2-1/2"

11/32" X 1-5/8"

11/32" X 1-1/8"

11/32" X 5/8"

DEC 14 2018

- 1/16" - 00 Gothic
- 3/32" - 00 Roman
- 3/32" - 0X Gothic
- 1/8" - 0 Gothic
- 1/8" - 0 Roman
- 5/32" - 1 Gothic
- 5/32" - 1 Roman
- 3/16" - 2 Gothic
- 3/16" - 2 Roman
- 1/4" - 2.5 Gothic
- 1/4" - 2.5 Roman
- 5/16" - 3 Gothic
- 5/16" - 3 Roman
- 7/16" - 4 Gothic
- 7/16" - 4 Roman
- 9/16" - 5 Gothic
- 9/16" - 5 Roman
- 11/16" - 6 Gothic
- 11/16" - 6 Roman

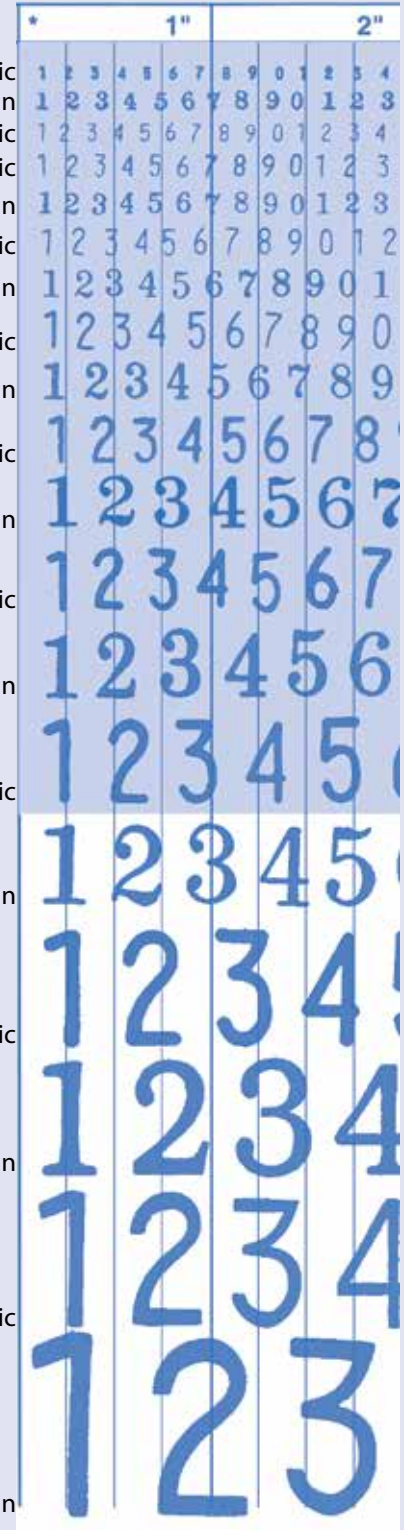

RIB-TYPE

Standard **Rib-Type** sets contain an assortment of alphabet and numerical characters using a Gothic Regular font that contains extra pieces of commonly used characters and fewer of rarely used characters.

An A-Font contains the following distribution of characters: 5-A, 4-B, 5-C, 4-D, 6-E, 4-F, 4-G, 4-H, 5-I, 2-J, 5-L, 4-M, 5-N, 5-O, 4-P, 2-Q, 5-R, 5-S, 5-T, 3-U, 3-V, 3-W, 2-X, 3-Y, 2-Z, 3-1, 2-2, 2-3, 2-4, 2-5, 2-6, 2-7, 2-8, 2-9, 3-0, 4-., 4-., 2-’, 1-\$, 1-&, 1-¢

Larger character sets contain fewer characters, but in the same proportion.

Numeric type sets (F) meaning figures, contain 5 of each character in sizes 1/16” - 9/16” and 4 each in sizes 3/16” and larger. Special Rib-Type logos or type styles can be furnished upon request.



Office Outfits

Sets contain complete A-Font plus a holder for three lines of type, tweezers (to handle the characters), and an ink pad. Have a couple of these handy sets around for those rubber stamps you need right now! Available in sizes 1/8” - 1/4”.

TRADITIONAL HAND STAMPS

Hand Stamps

The traditional hand stamp comes with either a photopolymer or natural rubber die and uses a separate stamp pad to ink it. These stamps are ideal for those times that no other stamp will do.

The photopolymer die is used with any water-based ink. The natural rubber die can be used with alcohol and latex based inks and great for stamping on non-porous surfaces.



Ideal & Trodat Stamps

Xstamper Stamps

Maxlight Stamps

2000+ Stamps

Industrial Stamps & Numberers

Rib Type & Traditional Hand stamp

Inks & Embossers

Stencils & Marking Devices

Corporate Supplies

Namebadges

Engraved Signs

Interior Signage

Award Plaques Cast Bronze Plaques

Stamped/Animal Tags

Industrial Nameplates & Labels

INKS

STAMP PADS

Felt stamp pads used for Poly and Rubber stamps. **Colors Available:** Black, Red, Blue, Green, Purple, Dry

Item #	Description
PS00	1-3/4" x 2-1/2"
PS0	2-1/4" x 3-1/2"
PS1	2-3/4" x 4-3/8"
PS2	3-1/16" x 6-1/8"
PS3	5" x 7"

IDEAL STAMP PAD INK

Used for stamp pads and Self-Inking stamps. Specifically formulated to give maximum speed of penetration. **Colors Available:** Black, Red, Blue, Green, Purple, Brown, Hot Pink, Orange
Sizes Available: 1 oz, 2 oz, Liter

XSTAMPER INK

For use with Xstamper Pre-Inked stamps only, any other ink will void the Xstamper warranty.

Colors Available: Black, Red, Blue, Green, Purple, Orange
Special Colors Available: Light Blue, Light Green, Pink, Yellow
Sizes Available: 10 ml, 20 ml, 60 ml, 5 cartridge pack

DAPON INK

For use with Dapon, Royal Mark and Perma stamps.

Colors Available: Black, Red, Blue
Sizes Available: 6 cc

MAXLIGHT INK

For use with MaxLight Pre-Inked stamps.

Colors Available: Black, Red, Blue, Green, Purple
Special Colors Available: Burgundy, Brown, Process Blue, Yellow, Florescent Pink, Red & Orange
Sizes Available: 1/4 oz, 2 oz

UTLIFAST INK

For use with Ultifast Pre-Inked stamps.

Marks on: plastic, metal, glass, photos
Dry time: 20-30 seconds
Colors Available: Black, Red, Blue
Sizes Available: 6 cc, 2 oz

ULTIMATE INK

Use with Rubber Die only.

Marks on: plastic, metal, glass, photos
Dry time: 15 seconds.

Colors Available: Black, Blue, Red, Green, White, Yellow.
Sizes Available: 2 oz, 8 oz, Pint, Quart

ULTIMATE THINNER

For use with Ultimate Ink. Cleans your stamp and reactivates/thins ink that has dried in your pad.

Sizes Available: 2 oz, 8 oz, Pint, Quart

C917 INK

Use with Rubber Die only.

Marks on: plastic, metal, glass, photos
Dry time: 30 seconds.

Colors Available: Black, Blue, Red, Green, White, Brown
Sizes Available: 2 oz, 8 oz, Pint, Quart

C917 THINNER

For use with C917 Ink. Cleans your stamp and reactivates/thins ink that has dried in your pad.

Sizes Available: 2 oz, 8 oz, Pint, Quart

NUMBERING MACHINE INK

Do not use with Poly or Rubber dies. Oil-base ink used in metal wheel numbering and dating machines.

Colors Available: Black, Red, Blue
Sizes Available: 2 oz, Quart

FROZEN FOOD INK

For marking packages in low temperature cases. Best for light colored surfaces.

Colors Available: Red, Purple
Sizes Available: 2 oz, 8 oz, Pint

SUPERMARKING INK

(Formerly Grocery Marking Ink)

Use with Rubber Die only.

Good for stamping metal cans, waxed paper, foil cartons, glass, & photos.
Colors Available: Black, Red, Blue, Green, Purple
Sizes Available: 4 oz, Pint, Quart

INVISIBLE INK

for Stamping on Skin

Ink will show up only under a black ultraviolet light. Shows blue under light.

Sizes Available: 4 oz

INVISIBLE INK

for Industrial Purposes

Can be used for glass, cellophane, cotton, etc. Shows blue under light.

Sizes Available: 4 oz

ULTIMARK INK

For Use with Ultimark Pre-Inked stamps.

Used on porous surfaces.

Colors Available: Black, Red, Blue, Green and Violet
Sizes Available: 1/2 oz, 2 oz

INDELIBLE CLOTH MARKING INK

Use with Rubber Die only.

Used for marking on cloth such as cotton, linen or rayon. Not affected by frequent laundering.

Colors Available: Black, Red, Blue, White
Sizes Available: 4 oz

JUSTRITE THINNER & CLEANER

Thins down heavy-bodied JustRite stamp inks which may thicken in the bottle. Use to recondition caked pads.

Sizes Available: 4 oz, Pint, Quart, Gallon

AERO #1250 /**MARK II REVERSIBLE PAD**

Use with Rubber Die only.

Two sided stamp pad. Use for non-absorbent surfaces such as foil, metal electronic parts, coated paper or plastic. For use with Aero #1250/Mark II ink.

Available inked or dry
Colors Available: Black, Red, Blue, Dry

INKS

AERO #1250 / MARK II INK

Use with Rubber Die only.

Use for non-absorbent surfaces such as foil, metal, cellophane, electronic parts, mylar, coated paper or plastic. Use this ink on dry, un-inked pad or Mark II Reversible pad. USDA approved for food packaging.

Dry time: 10-15 seconds

Colors Available: Black, White, Red, Blue, Green, Purple, Orange, Yellow

Sizes Available: 4 oz, Pint, Quart

AERO #1250 / MARK II REACTIVATOR

Use with Rubber Die only.

Specially formulated to rejuvenate dried Mark II stamp pads and clean stamps used with the Aero #1250 ink.

Sizes Available: 4 oz, Pint, Quart

DIAGRAPH MULTI-PURPOSE STENCIL INK

Waterproof, permanent, and fast-drying on most surfaces; marks on any porous or non-porous surface.

Colors Available: Black, Red, Blue, Green, White, Yellow, Orange

Sizes Available: Quart, Gallon

2 PART EPOXY INK

Use with Rubber Die only.

ADE Series Epoxy Screen Ink is formulated with high-quality epoxy resins for excellent adhesion to a wide range of hard-to-print surfaces providing outstanding solvent, chemical and abrasion resistance. ADE Series must be mixed with catalyst prior to use. 24 hours is required to achieve full cure. Meets mill spec: MIL-I-43553

Colors Available: Black, White

Sizes Available: 12.5 g packet, Quart

EMBOSSERS / SEALS

Embossers and seals allow you to crimp your paper with a crisp, clear impression. Reinforced, high strength steel is used in the construction to ensure quality and durability. With the easy lock mechanism its convenient for handling and storage. Many stock images are available: State, Architect, Engineer, Professional, Notary, Corporate and Religious. Looking for something different, design your own!

Impression Inker allows you to highlight the impression on your document for easier reading.
2" diameter



Custom Embossers and Seals

Illustrations and artwork may be provided. Please supply black and white camera ready vector artwork proportional to reproduction for quoting and ordering purposes.



(Actual size)

Pocket



Convenient, compact and portable. Comes with snap front vinyl case. Available in 1-5/8", 1-3/4", 2" diameters and 1" x 2"

Desk

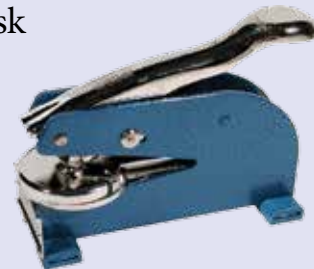

Solid base of four non-skid feet provides for stable desk top use. Available in 1-5/8", 1-3/4", 2" diameters and 1" x 2" Standard and Long Reach available.

Ideal & Trodat Stamps

Xstamper Stamps

Maxlight Stamps

2000+ Stamps

Industrial Stamps & Numbers

Rib Type & Traditional Hand Stamp

Inks & Embossers

Stencils & Marking Devices

Corporate Supplies

Namebadges

Engraved Signs

Interior Signage

Award Plaques Cast Bronze Plaques

Stamped/Animal Tags

Industrial Nameplates & Labels

STENCIL PRODUCTS

From concrete to asphalt, metals to wood, you'll find stencils to suit most any project. Our stencils are made from either a high quality mylar .010 film which has the advantages of strength and flexibility, ease of cleaning and transparency or .015 oilboard for a more disposable one time use project. Every stencil is laser or hand cut to your custom specifications.

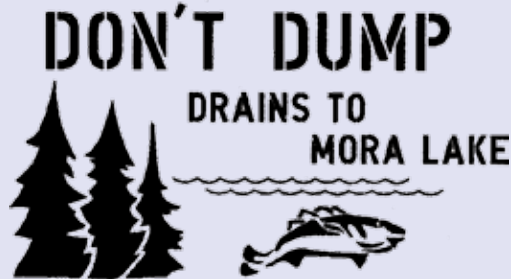

Diagraph Multi-Purpose stencil ink has been specially formulated to meet the most stringent quality control standards. Diagraph ink is waterproof, light resistant, permanent and fast drying on most surfaces and marks on any porous or non-porous surface.

Colors Available: Black, Blue, Red, Green, White, Yellow, Orange
Sizes Available: Quart, Gallon



For use with Diagraph Multi-Purpose inks we also have pads, Fountain Rollers in 3" and 1-1/2" sizes, replacement rollers and Fountain Brushes available.

METAL MARKING DEVICES

Handheld Steel Figures and Letters are designed to be struck with a hammer and are used for occasional marking on leather, wood or metal.

Available in Standard Duty sizes 1/16" - 1/2" and Heavy Duty sizes 1/32" - 5/8"

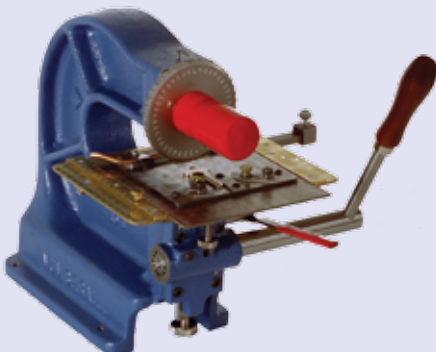
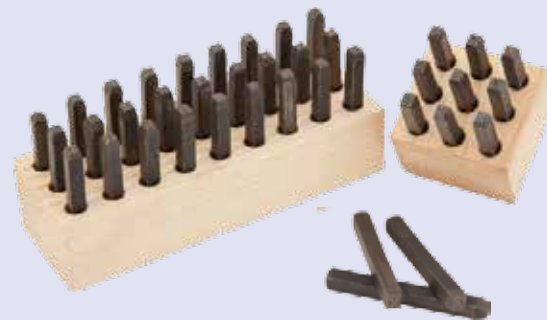

Detail Press Model 40B is used to stamp variable information on nameplates and tags quickly. Simply dial the letter or number and pull down on the handle.

Available in character sizes from 1/16" to 3/16"

Please contact Customer Service for more information



Jackson Record Book (Black)

This sturdy leatherette book has a thick cover and a rounded spine for display of company name. Two round posts allow easy additions from both front and back. Contents include Articles of Incorporation, By-Laws, 100 Minute Pages, and 12 - JT1334 Stock Certificates and stubs.

No. 14 Corporate Record Book (Red)

This sturdy leatherette book with a thick cover and a rounded spine for display of company name. Two rounded posts allow easy additions from both front and back. Contents include: approx. 100 blank pages, index tabs for articles, By-Laws, Minutes and Certificates with Stock Transfer Sheets in back.



Organizational Record Book

Blue Vinyl three ring binder with 1-1/4" capacity comes with matching vinyl slip case and spine display of company name. Contents include tabs for LLC and minute paper.



Impression Inker for embossed impressions pictured on page 19.



Goes KG2 certificates come with standard language printing on front and back with eagle vignette. Custom printing is available for Corporate name.
Color Available: Green only



101A Stock certificates come preprinted with standard language printing on front and back, back only printing or completely blank.
Colors Available: Green, Blue or Orange



JT1334 certificates come preprinted with standard language. Each certificate also comes with a stub for easy recording and are available for Minnesota or Interstate corporations. Sold by the dozen
Colors Available: Green only

- Stampers
- Maxlight
- 2000+
- Industrial
- Rib Type & Traditional
- Inks & Embossers
- Stencils & Marking Devices
- Corporate Supplies
- Namebadges
- Engraved Signs
- Interior Signage
- Anvord Plaques Cast Bronze
- Stamped/Animal Tags
- Industrial Nameplates & Labels

PERSONALIZED NAME BADGES

Engraved Name Badges are available in both the *standard* (front engravable) and the *executive* (reverse engravable) plastic, 1" x 3" and 1-1/2" x 3", however, other sizes are available.



Hot Stamped Name Badges

Hot stamping is a fabrication which fuses a thin plastic foil onto the badge with heat and pressure. This ensures a durable image which resists weathering and abrasion.



Printed Name Badges

Enhance your look and brand awareness with a multi-colored logo or message on your name badge. This badge is cost effective in larger quantities.

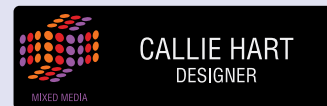

With a wide range of **fasteners** such as; the Locking Pin, Bulldog Clip, Clutch, Magnet, Strap Clip or Clear Pocket Adaptor your badge can be securely attached to any article of clothing.

Unless specified the Locking Pin comes standard on all name badges.



Ideal & Trodat Stamps

Xstamper Stamps

MaxLight Stamps

2000+ Stamps

Industrial Stamps & Numberers

RibType & Traditional Hand Stamp

Inks & Embossers

Stencils & Marking Devices

Corporate Supplies

Namebadges

Engraved Signs

Interior Signage

Award Plaques Cast Bronze Plaques

Stamped/Animal Tags

Industrial Nameplates & Labels

Only the highest quality plastic is used for our name badges and signage. With over 40 color choices in stock we can match your business colors and office decor. Other processes and materials are available to serve your particular needs.

Color Descriptions

022-402 BLACK/WHITE	TM 10 GRAY/WHITE	122-407 BLACK/YELLOW	122-304 GRAY/BLACK	022-204 WHITE/BLACK	022-206 WHITE/RED	022-205 WHITE/BLUE
322-814 PARCHMENT/ BLACK	022-602 RED/WHITE	222-022V BURGUNDY/ WHITE	022-512 BLUE/WHITE	122-552 NAVY/WHITE	322-962 TEAL/WHITE	222-562 LIGHT BLUE/ WHITE
222-932 GREEN/WHITE	022-912 PINE GREEN/ WHITE	222-744 YELLOW/BLACK	222-842V BROWN/WHITE	EM 47 PLUM/WHITE	222-192 MEDIUM WALNUT/WHITE	WG 86 MAHOGANY/ WHITE
H394M RADIANT GOLD/ BLACK	522-734 BRUSHED GOLD/ BLACK	522-334 BRUSHED SILVER/ BLACK	522-344 SMOOTH SILVER/ BLACK			

Reverse Engraved Plastics

For a modern, classy look create your own custom nameplate with custom colors and text applied to the backside of the plate.

322-401 REVERSE BLACK	322-201 REVERSE WHITE	322-731 REVERSE GOLD	322-371 REVERSE SILVER

Type styles for Engraved Signs & Badges

ABCDEFGHIJKLMNOPQRSTUVWXYZ
abcdefghijklmnopqrstuvwxyz
GOTHIC

ABCDEFGHIJKLMNOPQRSTUVWXYZ
abcdefghijklmnopqrstuvwxyz
*** ROMAN ***

ABCDEFGHIJKLMNOPQRSTUVWXYZ
abcdefghijklmnopqrstuvwxyz
CURSIVE

ABCDEFGHIJKLMNOPQRSTUVWXYZ
abcdefghijklmnopqrstuvwxyz
HELVETICA

* additional charge may apply for this style

Ideal & Trodat Stamps

Xstamper Stamps

Maxlight Stamps

2000+ Stamps

Industrial Stamps & Numberers

Rib Type & Traditional Hand Stamp

Inks & Embossers

Stencils & Marking Devices

Corporate Supplies

Namebadges

Engraved Signs

Interior Signage

Award Plaques Cast Bronze Plaques

Stamped/Animal Tags

Industrial Nameplates & Labels

ENGRAVED WALL & DESK SIGNS



Engraved message inserts are made from durable plastic and are available in a choice of over 40 colors. Traditional wall and desk holders are manufactured from anodized aluminum for long lasting durability. Please specify background color and message color when ordering (refer to page 22).

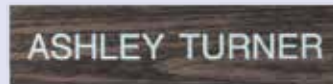

plate only



corridor



wall sign



acrylic base with plastic plate



desk sign

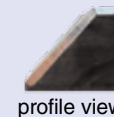

black brass plate on wood

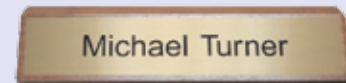
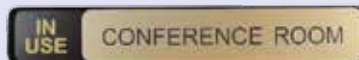

plastic plate on wood

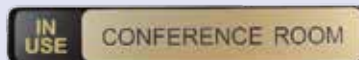

changeable wall sign

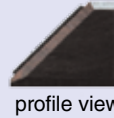

Mounting options: Clear Adhesive (on front), Velcro, Suction Cups, Double-sided Tape (on back), Magnetic Tape or Screw Holes.

CUSTOM ENGRAVED SIGNS

For a unique look, create your own custom sized signage. Custom Signage is a great choice for your counters, walls and doors.

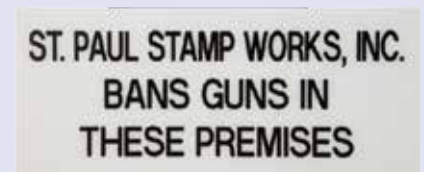
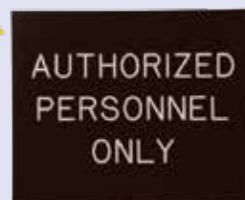

DESIGNER/ARCHITECTURAL SIGNS

Our Engraved Designer/Architectural Wall & Desk Signs have been engineered as a quality interior sign system and features a distinctive professional look that matches any modern office environment.

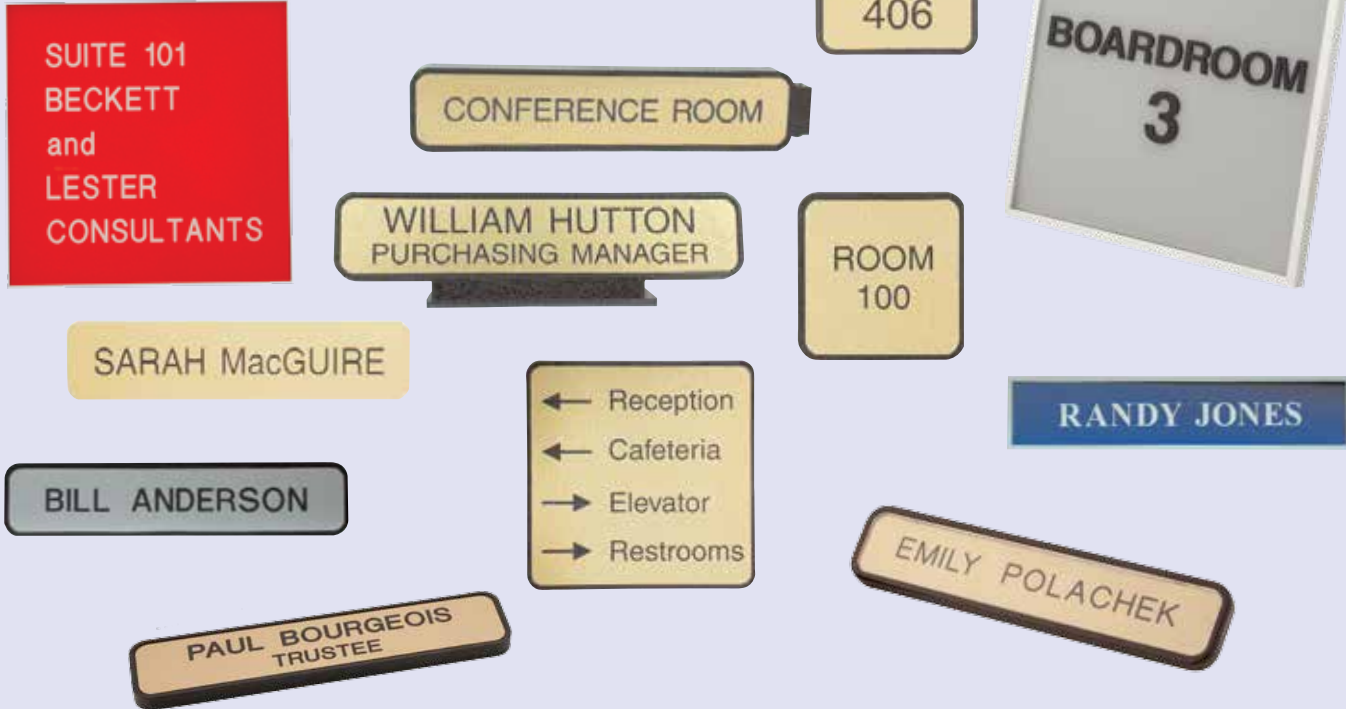

ADA SIGNAGE

Whether you choose a stock sign or to custom make your own unique design. ADA is a great way to let Architects & Designers create a masterpiece. Contact customer service for a full list of our stock ADA Signage.



Ideal & Trodat Stamps

Xstamper Stamps

MaxLight Stamps

2000+ Stamps

Industrial Stamps & Numbers

RibType & Traditional Hand Stamp

Inks & Embossers

Stencils & Marking Devices

Corporate Supplies

Namebadges

Engraved Signs

Interior Signage

Award Plaques Cast Bronze

Stamped/Animal Tags

Industrial Nameplates & Labels

GRAPHIC INTERIOR SIGNAGE

Allenite Quality is backed with more than a century filled with end users of our signs, directories and interior graphics that are overly satisfied with our products. Creativity combined with craftsmanship are the hallmarks of Allenite Signs. The standard designs shown here are only the beginning.

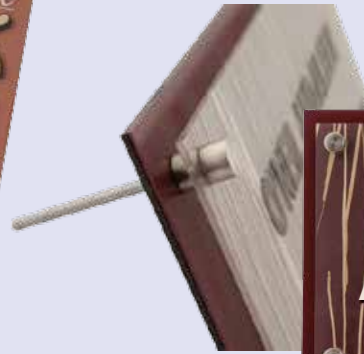

DIRECTORY SIGNS

We take pride in manufacturing custom designed directories which will compliment and enhance your interior lobby areas.



Please contact Customer Service for more information

Ideal & Trodat Stamps

Xstamper Stamps

MaxLight Stamps

2000+ Stamps

Industrial Stamps & Numberers

RibType & Traditional Hand Stamp

Inks & Embossers

Stencils & Marking Devices

Corporate Supplies

Namebadges

Engraved Signs

Interior Signage

Award Plaques Cast Bronze Plaques

Stamped/Animal Tags

Industrial Nameplates & Labels

AWARD PLAQUES

Our complete line of awards include solid walnut, oak, veneers and a variety of Plexiglass. With a wide variety of sizes and plate colors available, you can honor your award recipient in style.



Ideal & Trobat Stamps
 Xstamper Stamps
 Maxlight Stamps
 2000+ Stamps
 Industrial Stamps & Numbers
 Rib Type & Traditional Hand Stamp
 Inks & Embossers
 Stencils & Marking Devices

CAST BRONZE PLAQUES

“The Eternal Metal”

Used for over 5000 years, bronze is known as the “metal of the ages” for its beauty and endurance. Cast Bronze and Cast Aluminum plaques are made by pouring molten metal into sand molds. The casting process creates plaques with two (2) levels of graphics - raised and recessed. Often used for dedication plaques, religious and fraternal insignias, service and merit awards and building identification.



Background



Leatherette



Travertine



Pebbled (limited to 30" x 40" size)



Sculptured

Borders



Bevel Edge



Double Line



Single Line Bevel Edge

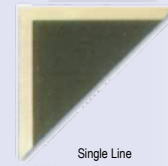

Single Line

Corporate Supplies
 Namebadges
 Engraved Signs
 Interior Signage
 Award Plaques Cast Bronze Plaques
 Stamped/Animal Tags
 Industrial Nameplates & Labels

STAMPED TAGS

Stamped Tags can be furnished with holes or permanent adhesive and with large easy to read text or numbers that are perfect for numbering church pews, chairs and seats, classroom doors, lockers, fixtures, shelves, baskets, cabinets, bins, drawers, containers; for inventory and identification of machinery and equipment, manufactured articles and sample boards.



ANIMAL LICENSE TAGS

These tags are made of 20 gauge (.032") brass or 16 gauge (.050") aluminum. The aluminum can be anodized gold, green, red, blue or plain (natural) and is available in 13 different shapes. The characters are sunken for maximum durability. Reinforced Holes are also an option for longevity. Type is not standard and can be changed to meet your specifications.

Accessories include: S links packed in bulk or can be attached to tags for an additional cost. Split rings available in bulk only.



Tags Available in:



Style #25



Style #27



Style #36



Style #53



Style #55



Style #57



Style #85



Style #93



Style #95



Style #97

Animal Receipt Books

ANIMAL LICENSE	
Tag No. _____	Treasurer's Office: _____ 20__
RECEIVED OF _____	
\$ _____ in full payment of City License on Female _____	
for year ending _____ 20__	
Dog _____	Cat _____
Name _____ Color _____ Breed _____	
_____ City Treasurer or Tax Collector	



Style #20



Style #21



Style #23

SCALES

Where precise measurements are required, reproduction of increments can be held as tight as $\pm .005$ ".

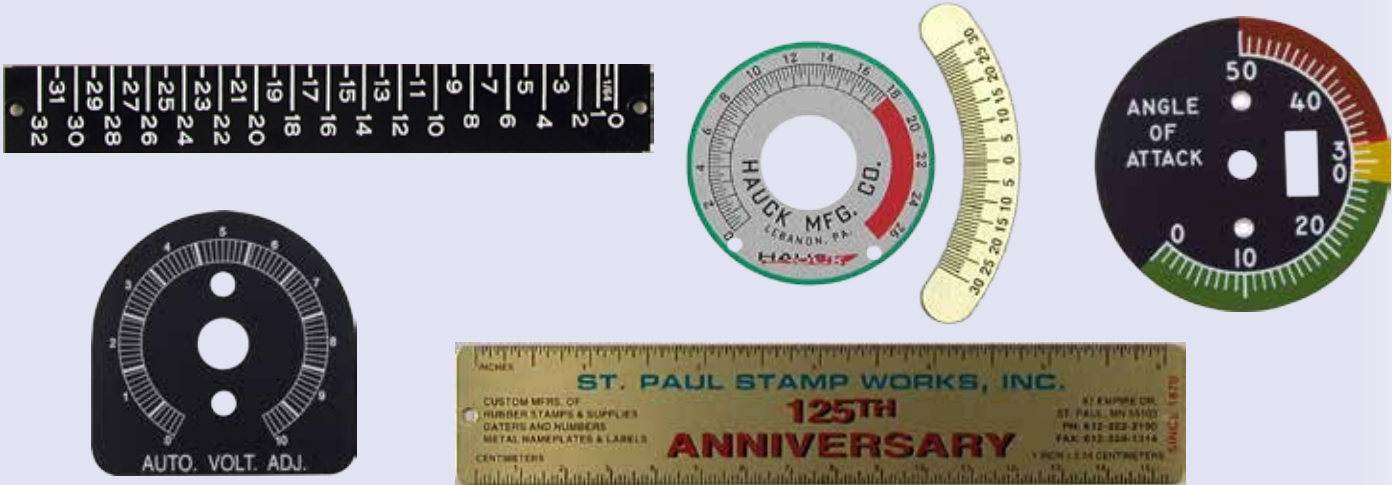

BARCODE / UID PLATES

Bar coding improves the efficiency of asset control with optically readable data. It is available in linear, parallel lines or condensed two dimensional (2D) formats. Bar codes are reproduced photographically on sealed, anodized aluminum ranging in thickness from .003 inches to .060 inches, resulting in one of the most durable plates available. Tolerances on bar code widths can be held to .001 inches.



PROMOTIONAL PLATES

Unique promotional ideas! Metal plates are very distinctive and they gain the attention of prospective customers at a reasonable price.



Ideal & Trodat Stamps
 Xstamper Stamps
 Maxlight Stamps
 2000+ Stamps
 Industrial Stamps & Numbers
 Rib Type & Traditional Hand Stamp
 Inks & Embossers
 Stencils & Marking Devices
 Corporate Supplies
 Namebadges
 Engraved Signs
 Interior Signage
 Award Plaques
 Cast Bronze Plaques
 Stamped/Animal Tags
 Industrial Nameplates & Labels

SCHEMATICS

When technical information needs to be conveyed for service or setup plates. Our Stonewear Process is an excellent choice for schematics and diagrams due to our ability to reproduce fine details clearly.

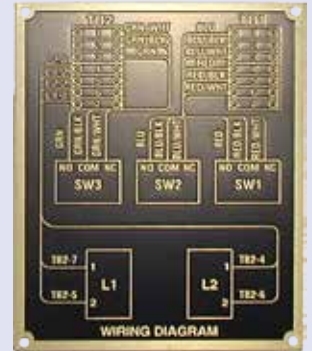
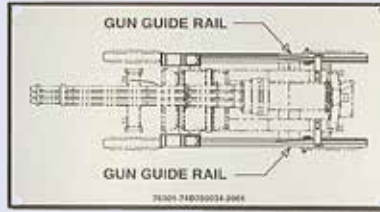
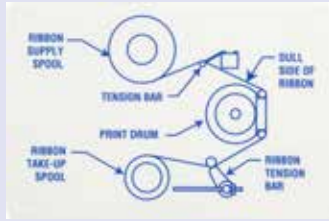

INVENTORY AND ASSET TAGS

These plates are being used increasingly by companies for permanent marking of all business property, office equipment as well as production equipment.



ALUMINUM FOIL

Our foil stock is .002" dead soft aluminum. This allows the customer to indent variable information onto the label with a conventional typewriter or by hand. (The carbon from most typewriters will not adhere to this material). Most customers prefer the labels left in strips for ease of typing. These labels can be laminated for extra durability.
NOTE: Please specify if you wish to have your labels left in strip form.

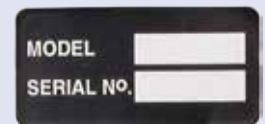
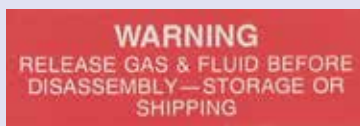

POLYESTER (MYLAR)

Our trade name for these labels is Stonewear Process Mylar Labels. These labels are extremely durable due to the fact that they are laminated with a protective covering. We also can provide these labels with serialized numbers.



DESTRUCTIBLE VINYL

This .002" thick material has the advantage that it can be written on with a pen and it is virtually impossible to remove intact and can be applied to curved surfaces. Uses include: security seals, warranty labels and date code labels.

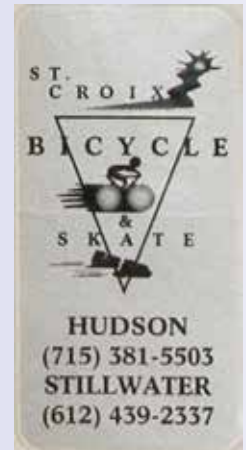
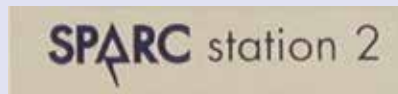

VINYL

Premium white exterior grade vinyl labels are long lasting and can have improved durability with our over laminate. The flexibility of this material makes it an excellent choice with applying labels to a curved surface. If your application is outdoors, please advise your account representative as there are situations where lamination is not recommended.



- Ideal & Trodat Stamps
- Xstamper Stamps
- Maxlight Stamps
- 2000+ Stamps
- Industrial Stamps & Numbers
- Rib Type & Traditional Hand Stamp
- Inks & Embossers
- Stencils & Marking Devices
- Corporate Supplies
- Namebadges
- Engraved Signs
- Interior Signage
- Award Plaques Cast Bronze Plaques
- Stamped/Animal Tags
- Industrial Nameplates & Labels

Ideal & Trodat Stamps
 Xstamper Stamps
 MaxLight Stamps
 2000+ Stamps
 Industrial Stamps & Stamp Numberers
 RibType & Traditional Hand Stamp
 Inks & Embossers
 Stencils & Marking Devices
 Corporate Supplies
 Namebadges
 Engraved Signs
 Interior Signage
 Award Plaques
 Cast Bronze Plaques
 Stamped/Animal Tags
 Industrial Nameplates & Labels

LEXAN

Lexan™, also known as polycarbonate has a variety of surface finishes and is subsurface printed giving the benefits of a durable yet decorative part. A label made of this material can be provided with clear windows for L.E.D. readouts. Available in .005", .010" and .020" thick Lexan. One of the benefits of polycarbonate is that it can be die cut into special shapes. Due to the nature of the material, tooling tolerances should not be less than .010" inches.



DIGITAL PRINTING

Digital printing is a relatively new technology which allows us to print multiple colors simultaneously via four color process. Additionally we can bypass the processes of making screens or litho plates. By using a four color process you can significantly improve the appeal of your plates with relatively low set up costs.



ETCHED PLAQUES & SIGNS

Etched plaques and signs have recessed letters which adds both beauty and durability. Etched stainless steel is probably the most durable of all the materials and is available in up to .125" thick. Etched bronze is a cost effective and very attractive alternative to the cast bronze products.



EMBOSSED METAL

Embossing conveys a sense of strength that is not available in any other type of plate. The 3-D look can be furnished in conjunction with one of our printing processes to accentuate your image or without color (blind emboss.) On most embossed plates there is a one time die charge.



DOMED LABELS

Domed labels are a decorative way to enhance your company name or logo. The clear resin of .040 - .060 thick over the label makes the image stand out.



MILITARY STYLE TAGS

Military style tags have become popular as promotional items. We can supply official rolled edge military style (1.120" x 2" x .014" stainless steel) with customized copy, or a similar 1.187" x 2.062" tag which is available in any of our stocked materials and in thicknesses ranging from .016" to .032". The 1.187" x 2.062" size tag can be etched, printed or embossed to fit your special needs.



Ideal & Trodat Stamps
 Xstamper Stamps
 Maxlight Stamps
 2000+ Stamps
 Industrial Stamps & Numbers
 Rib Type & Traditional Hand Stamp
 Inks & Embossers
 Stencils & Marking Devices
 Corporate Supplies
 Namebadges
 Engraved Signs
 Interior Signage
 Award Plaques Cast Bronze
 Stamped/Animal Tags
 Industrial Nameplates & Labels

ETCHED METAL

Etched metal nameplates are one of the most beautiful and durable of all nameplates. The etching process creates a relief of .003 - .005 deep so that even if the paint wears off the image will remain. We can manufacture these plates in all of our stocked metals in thicknesses ranging from .018" to .125". Larger plates can serve the purposes of commemorative plaques or stunning signage. If even more relief is required ask about etched zinc plates.



PHOTOSENSITIVE

These parts are extremely durable, they have been tested for up to 20 years of UV exposure, and can be produced with the finest detail. The extended durability only applies to black images. In addition to these qualities photosensitive plates are an excellent choice for prototypes, short run orders or parts that have to meet military specifications.

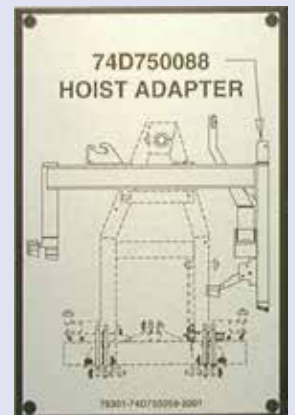
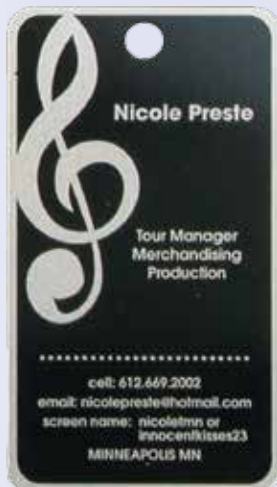
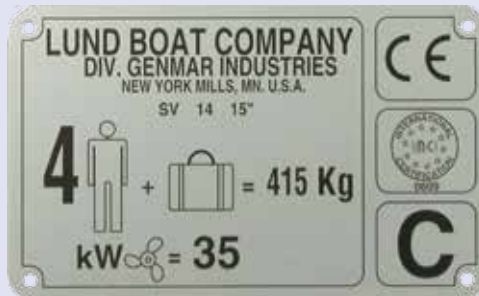

FACILITY IDENTIFICATION SIGNS

Your facility is unique, and it requires unique identification solutions. Standardize and personalize facility identification from the front gate of your facility to the back dock. A consistent look and feel creates a visually appealing, welcoming, safe and productive work environment. Personalizing your facility means providing identification solutions that help increase employee buy-in. Do this by using images of employees on signs, promoting your company brand or including safety slogans.



Ideal & Trodat Stamps
 Xstamper Stamps
 Maxlight Stamps
 2000+ Stamps
 Industrial Stamps & Numbers
 Rib Type & Traditional Hand Stamp
 Inks & Embossers
 Stencils & Marking Devices
 Corporate Supplies
 Namebadges
 Engraved Signs
 Interior Signage
 Award Plaques
 Cast Bronze Plaques
 Stamped/Animal Tags
 Industrial Nameplates & Labels

Ideal & Tradat Stamps

Xstamper Stamps

MaxLight Stamps

2000+ Stamps

Industrial Stamps & Numberers

RibType & Traditional Hand Stamp

Inks & Embossers

Stencils & Marking Devices

Corporate Supplies

Namebadges

Engraved Signs

Interior Signage

Award Plaques Cast Bronze Plaques

Stamped/Animal Tags

Industrial Nameplates & Labels

MODEL & SERIAL NUMBER PLATES

These plates provide important information necessary for warranties and limitation of product liability. Serialization and variable data may be stamped on these plates for a nominal cost.



WARNING & INSTRUCTIONAL PLATES

Manufacturers, in an effort to reduce product liability, and to instruct operators in the proper operation of their equipment, will frequently use these labels.



DECORATIVE TRIM PLATES

Our Stonewear Process Metal Plates are printed to your specification and overcoated with a tough baked on finish. These plates are made to the highest nameplate standards as established by "GPI" the nameplate trade association. In addition to our overcoat, all decorative trim nameplates have a removeable premask to protect against scratches. Please specify decorative trim nameplates if you desire these unusually high standards.



**INDUSTRIAL NAMEPLATES
REQUEST FOR QUOTE SHEET**

for use with pages 29 - 36

Company _____ Date _____

Address _____ Phone _____

_____ Fax _____

Contact name _____

Email address _____

Marking method: Printed _____ Digital _____ Domed _____ Etched _____

Embossed _____ Engraved _____ Photosensitive _____ Other _____

Part size _____ Material _____ Thickness _____

How many colors? _____

Does ink bleed of edge of part? _____ Is logo involved? _____

No. of holes _____ Slots _____

Adhesive _____ Corners: Square _____ Round _____

Serialized Yes _____ /No _____ *standard is 1/8" stamped unfilled numbers*

Indoor _____ Outdoor _____ Decorative _____

Type of surface part will be applied to: _____

(such as type of plastic, type of paint if painted, etc.)

****please be as specific as possible****

Describe the environment plates will be subjected to: _____

****Standard Tolerance is +/- .015 - If tighter tolerance is required please specify

****Application for Macintosh: Adobe Illustrator CS6, Quark 9.0, Photoshop CS6 or Adobe InDesign CS6.

Format file: Vector art saved as: ai, eps, pdf, tiff, pict. With tiff and pict files we need CMYK and a minimum of 300 dpi.

Quantities: _____

Additional Comments: _____

Please send print or sketch if available.

DATE _____ CUST. ACCT. # _____
 P.O. _____ ORDERED BY _____
 PHONE _____ FAX _____



507-387-4444 • FAX 507-387-4447
 P.O. Box 1029
 Mankato, MN 56002-1029
 custserv@dmstampsdiv.com

B _____
I _____
L _____
L _____
T _____
O _____

S _____
H _____
I _____
P _____
T _____
O _____

SHIPPING
 FedEX Ground
 FIRST CLASS
 available if under \$30.00
 C.O.D.
 PICKUP
 OTHER:

Invoice Pre-Pay Credit Card: Visa MC AMEX _____ Exp _____

MAIL OR FAX THIS ORDER DIRECTLY TO DM STAMPS & SPECIALTIES
PH. 507-387-4444 • FAX 507-387-4447 • P.O. BOX 1029 • MANKATO, MN 56002-1029

USE SEPARATE ORDER BLANK FOR EACH ITEM

STAMPS		SIGNS & BADGES		EMBOSSERS	
ITEM NO.	QUANTITY	QUANTITY _____		QUANTITY	POCKET EMBOSSER <input type="checkbox"/> 1-5/8" <input type="checkbox"/> 1-3/4" <input type="checkbox"/> 2" <input type="checkbox"/> 1" x 2" DESK EMBOSSER <input type="checkbox"/> 1-3/4" <input type="checkbox"/> 2" <input type="checkbox"/> 1" x 2"
PRE-INKED <input type="checkbox"/> ULTIMARK <input type="checkbox"/> BLACK <input type="checkbox"/> RED <input type="checkbox"/> BLUE <input type="checkbox"/> GREEN <input type="checkbox"/> PURPLE <input type="checkbox"/> X-STAMPER <input type="checkbox"/> BLACK <input type="checkbox"/> RED <input type="checkbox"/> BLUE <input type="checkbox"/> GREEN <input type="checkbox"/> PURPLE		SIZE: H _____ " X W _____ " IMPRINT COLOR: _____ BACKGROUND COLOR: _____ LOGO COLOR: _____ <i>Indicate logo size and location with copy.</i>		EMBOSSEMENT EDGE: <input type="checkbox"/> Env. Flaps Letterheads <input type="checkbox"/> Left <input type="checkbox"/> Right <input type="checkbox"/> Top <input type="checkbox"/> Bottom	
SELF-INKING <input type="checkbox"/> IDEAL <input type="checkbox"/> TRODAT <input type="checkbox"/> 2000+ <input type="checkbox"/> BLACK <input type="checkbox"/> RED <input type="checkbox"/> BLUE <input type="checkbox"/> GREEN <input type="checkbox"/> PURPLE <input type="checkbox"/> REPLACEMENT PAD MODEL _____ COLOR _____ <i>Black ink will be used unless specified.</i>		HOLDER DESC: _____ <i>(Color, Material & Size)</i> <input type="checkbox"/> DESK <input type="checkbox"/> WALL SCREW HOLES: <i>Indicate location with copy.</i>		QUANTITY <input type="checkbox"/> STAMP PAD (for hand stamps) <input type="checkbox"/> Standard: #1 (2-3/4" x 4-1/4") SPECIAL SIZE _____ COLOR _____	
HAND STAMP <input type="checkbox"/> TRADITIONAL HANDLE <input type="checkbox"/> MOLDING <input type="checkbox"/> OTHER _____		HOLES _____ SIZE _____ " <input type="checkbox"/> VELCRO <input type="checkbox"/> STICKY BACK <input type="checkbox"/> FOAM TAPE		QUANTITY <input type="checkbox"/> INK BRAND _____ COLOR _____	
TYPESETTING INSTRUCTIONS: <input type="checkbox"/> Center (<i>Centered is standard</i>) <input type="checkbox"/> Justify <input type="checkbox"/> Flush Left <input type="checkbox"/> Flush Right <input type="checkbox"/> CAPS <input type="checkbox"/> Upper/Lower <input type="checkbox"/> Add Border Font: _____ Char. Size: _____ If copy does not fit, please: <input type="checkbox"/> Change Item Size <input type="checkbox"/> Change Type size					

IMPRINT COPY TO READ:

CAMERA READY ARTWORK - SIGNATURES will be used at 100% unless otherwise specified.

FORMAT
(if known)

Special Instructions:

Note: Signatures must be written in actual size in black ink. For logos and artwork submit exact size of original black and white camera-ready art via mail or e-mail. Photocopies of artwork cannot be accepted. If color is not specified, black ink will be used. If typesetting instructions are not provided, we will use our discretion to make the best finished product.

DM Stamps & Specialties

1101 N. Riverfront Drive • Mankato, MN 56001

507-387-4444 • Fax: 507-387-4447

Email: custserv@dmstampsdiv.com

www.dmstampsdiv.com

ADA SIGNAGE • AWARD PLAQUES

CAST BRONZE PLAQUES • DATERS & NUMBERERS

DESIGNER/ARCHITECTURAL SIGNS • DIRECTORY SIGNS

EMBOSSERS/SEALS • ENGRAVED SIGNS & BADGES

ETCHED PLAQUES • GRAPHIC INTERIOR SIGNAGE

HOT STAMPED BADGES & SIGNS • INDUSTRIAL STAMPS

INVENTORY & PROPERTY TAGS • LASER ETCHED PLATES

LEXAN LABELS • METAL NAMEPLATES

METALPHOTO PLATES • MYLAR & FOIL LABELS

PAPER LABELS • SELF-INKING STAMPS

STAMP ACCESSORIES • STAMPED TAGS

TRADITIONAL HAND STAMPS • XSTAMPER PRE-INKED STAMPS

